

*Hydro***FLOW**®



C RANGE

HYDROPATH Technology | The home of *Hydro***FLOW**®



Electrical Specifications

Transducer unit

Main unit: Anodised Aluminium
End plates: UL V-0 rated polycarbonate

Water and Dust Protection

IP Rating:
Transducer IP68 IEC 60529
PSU IP66 IEC 60529

Built-in EMI Filter

Meets: FCC 20780 Class B
VDE 0871 Level A

Safety

Europe and Worldwide:
IEC61010-190+A1:92 +A2:95 ~EN61010
Tested accorded to CENELEC National Requirements

USA: UL3101-1
Canada: CSA22.2 No:1010.1-92
CAN/CSA-22.2 No. 0.4-M1982

Over-voltage (Transients)

10 to 20% above nominal

Remote Monitoring Facility

Normally open circuit or 5V output
(Special terminated cable can be provided to facilitate connection)

Environmental Specifications

Installation category: Cat II; Altitude: <2000 Mtrs (6562'); Operating Temperature: -20 to + 50° C (-4 to 122°F);
Maximum relative humidity; Max 80% up to 31°C (87° F) decreasing linearly to 50% RH at 40° C (104° F)

Overload Protection

Continuous short or open circuit on all outputs.

Insulation

Basic insulation with the metal enclosure bonded to earth.

Servicing

No user repairable parts are fitted. Repair must be undertaken by an authorised repair centre.

Panel Indicators

The PSU is fitted with LED indicator lights. The Green LED indicates that the power is on, and the Red indicates that a signal is being transmitted.

CSA Certification and CB Test Certificate

In accordance with the
International (IEC) and
UL/CSA standards listed
above.



Manufactured to BSEN9002

To be installed in accordance with the
latest IEE wiring instructions.
Fuse rating: 1A.



To be installed in accordance with the
latest IEE wiring instructions.
Fuse rating: 1A.

Electrical Specifications

PSU Input voltage: 87 – 240V AC

Frequency: 47 – 63 Hz

PSU Model	LV1	LV2	HV	Input Power	Fuse Rated 250 V	Output Power
DEL638	+12V	+15V	+24 or 30 V*	20W max	1.6A (T)	14W
CP1	+12V	+15V	+24 or 30V*	25W max	1.0A (T)	15W
CP2	+12V	+15V	+35 or 90V*	65W max	1.0A (T)	45W

* Voltage depends on transducer model used

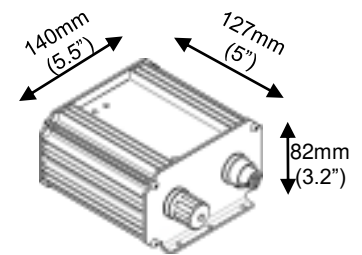
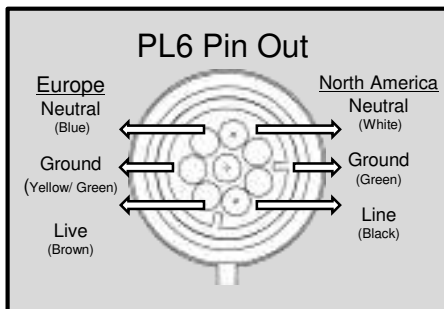
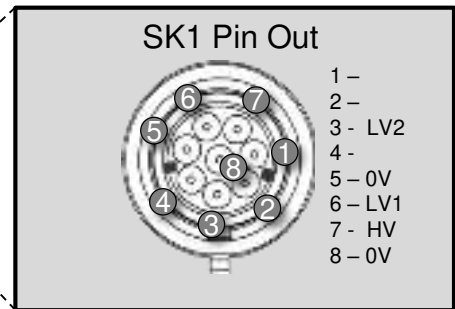
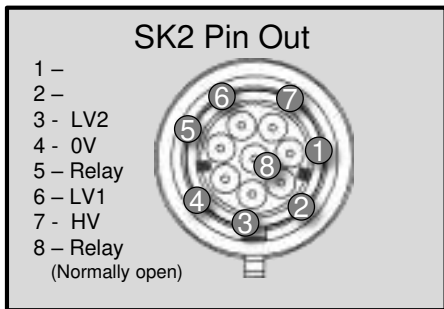

PSU Panel Indicators

GREEN: Power ON

RED: Signal is being transmitted

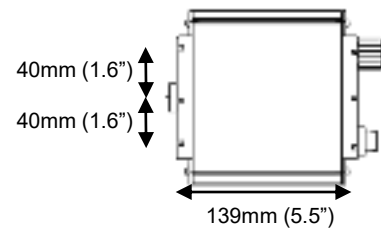

Transducer DC Input Voltage:

PSU Model	LV1	LV2	HV	Input Power
DEL638	+12V	+15V	+24 or 30V*	14W
CP1	+12V	+15V	+24 or 30V*	15W
CP2	+12V	+15V	+35 or 90V*	45W

* Voltage depends on transducer unit used

Hydropath may at times replace a particular unit with one of a higher specification without notice.



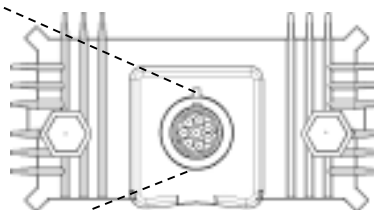

Viewed looking at connector end of transducer unit

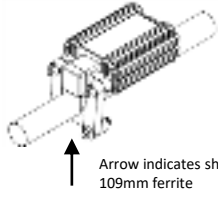
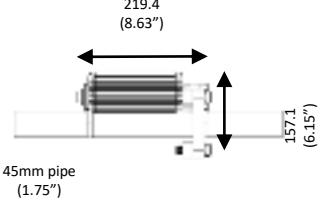
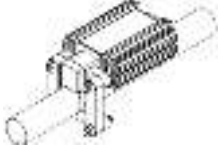
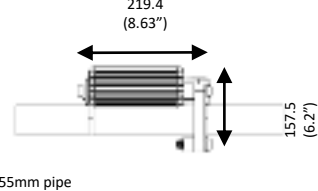
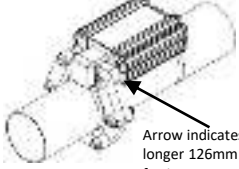
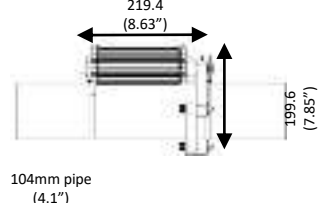

Mechanical Details

The **HydroFLOW** C Range water conditioner is specifically designed to combat limescale in commercial and/or industrial applications by clustering mineral ions. C Range units are most commonly used on heat exchangers and plumbing systems.

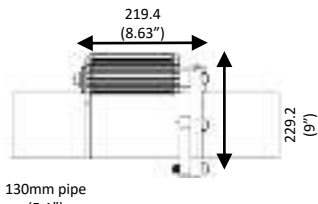
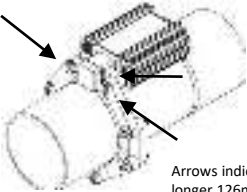
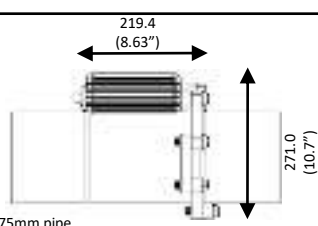
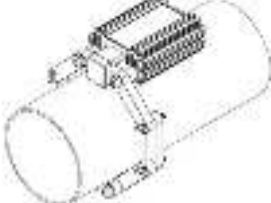
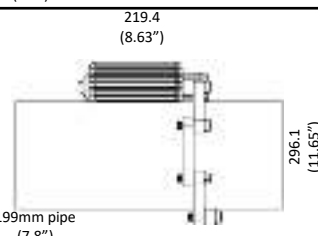
Model	Ferrite Arrangement	Dimensions mm (inches)	Ferrites	Total Weight kg (lbs)
C45	 Arrow indicates shorter 109mm ferrite	 45mm pipe (1.75")	1 x 109mm (4.25") 3 x 126mm (5.0")	4.1 (8.8)
C60		 55mm pipe (2.2")	4 x 126mm (5.0")	4.2 (9.2)
C100	 Arrow indicates longer 126mm ferrite	 104mm pipe (4.1")	5 x 109mm (4.25") 1 x 126mm (5.0")	4.4 (9.7)
C130		 130mm pipe (5.1")	6 x 126mm (5.0")	4.6 (10.1)
C150	 Arrows indicate longer 126mm ferrites	 175mm pipe (6.9")	5 x 109mm (4.25") 3 x 126mm (5.0")	5.4 (11.9)
C190		 199mm pipe (7.8")	8 x 126mm (5.0")	5.8 (12.8)

- All units draw less than 1 amp of current at 120V AC
- Listed weights include: Transducer unit, power supply, ferrites, cables and mounting hardware.

Assembly

DO NOT POWER UP UNIT UNTIL ALL FERRITES SUPPLIED ARE CONNECTED.

- The unit is supplied with a bracket for ease of mounting to the pipe. The two upper plates should be loosely secured with bolts before installation.
- Smaller units are secured to the pipe using steel clamps and bolts

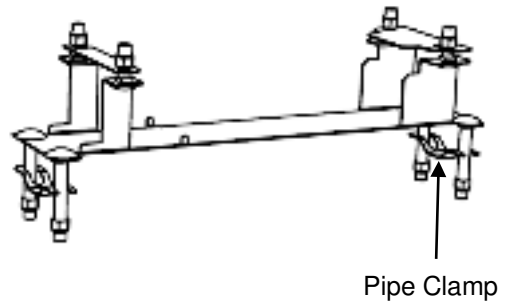

- For larger units, the brackets are supplied with stainless steel banding.
- Pass the two stainless steel bands through the slots in the bracket.

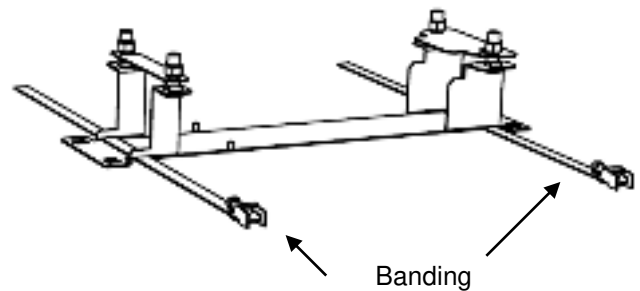

- Place the bracket on the pipe.
- If installing on a vertical pipe, place the bracket with the smaller plate upwards to ease fitting of hexagon nuts.
- Tighten steel hex nuts to secure clamps for smaller units
- Secure straps on larger units by tightening clamps with flathead screwdriver or hex socket driver

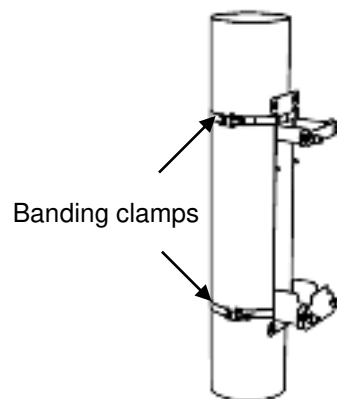

WARNING

The system must be used as specified. Failure to do so will prevent correct operation of device and may impair safety.

Assembly

DO NOT POWER UP UNIT UNTIL ALL FERRITES SUPPLIED ARE CONNECTED.

- Place the unit on the bracket and hold in place using the swinging plates.
- Secure by tightening the four steel nuts.

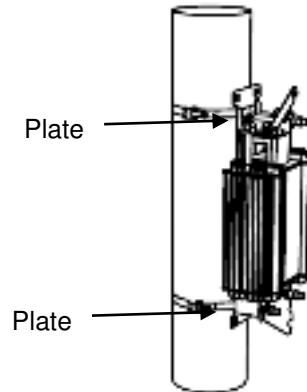

- Insert the two hexagon nuts into the holes in the end plate, next to the ferrite holding cage.
- The transducer unit is supplied with at least one **long** ferrite bar. Insert this through the holding cage until the holes line up with the hexagon nuts.

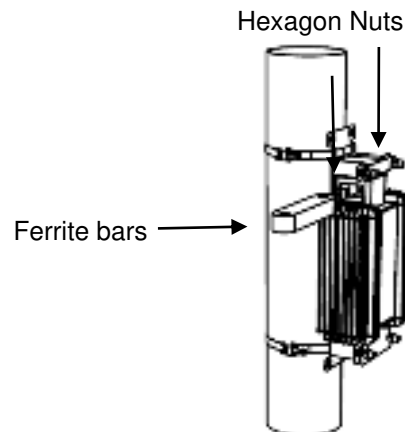

- Take a second ferrite, insert a plastic thumb screw through both ferrite bars and loosely screw into hexagon nut.
- Repeat on opposite side.

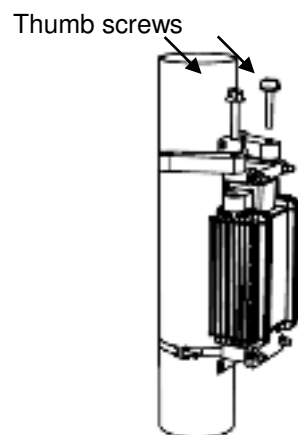

WARNING

The system must be used as specified. Failure to do so will prevent correct operation of device and may impair safety.

Assembly

DO NOT POWER UP UNIT UNTIL ALL FERRITES SUPPLIED ARE CONNECTED.

- Assemble **all** the other ferrites around the pipe according to the mechanical configuration specified for the unit.
- Loosely secure each ferrite with plastic thumb screws and thumb nuts.

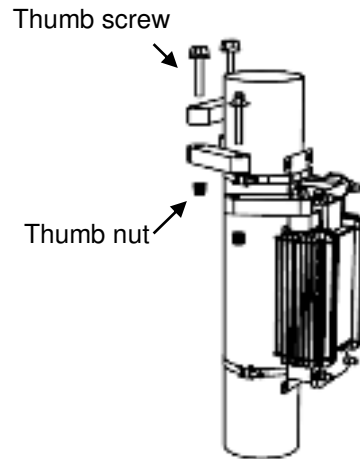

- Once the ferrite ring is complete, tighten all wing nuts until hand tight.
- **Do not over tighten as ferrites are fragile.**



WARNING

The system must be used as specified. Failure to do so will prevent correct operation of device and may impair safety.

Assembly

DO NOT POWER UP UNIT UNTIL ALL FERRITES SUPPLIED ARE CONNECTED.

- Install the Power Supply Unit (PSU) in a convenient position so that the LED lights can be easily viewed.
- In accordance with local code and regulations, connect the PL6 port to the electrical power supply (87V-240V AC).
- Connect between the PSU SK1 and the transducer SK1 port using the supplied interconnecting cable .
- Energise the electrical power supply and ensure that the Red and Green LED lights on the PSU are glowing brightly.

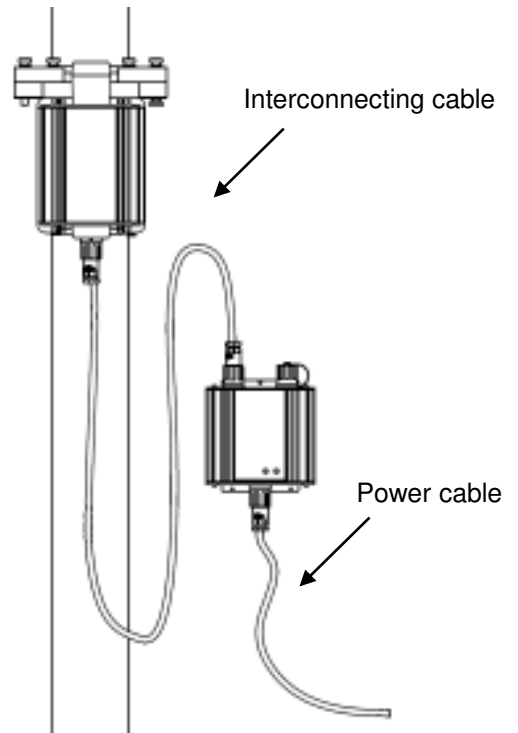

- **Remote Monitoring** is available for use with Building Management Systems (BMS). The cable (supplied separately) plugs into the SK2 port of the PSU, which is normally fitted with a protective cap.
- For additional information please contact an authorised representative.

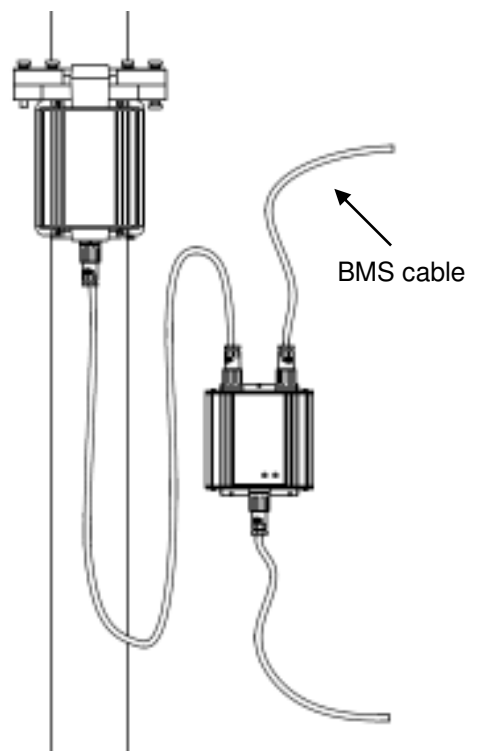

WARNING

The system must be used as specified. Failure to do so will prevent correct operation of device and may impair safety.

Location Criteria

HydroFLOW protects against limescale by causing the scale-forming ions to form clusters. When the water is heated, crystals form in suspension rather than as hard scale on surfaces.

- Fit *HydroFLOW* on the cold water supply to wherever the water is heated.
- Consider signal propagation barriers. Such barriers include non-conducting valves, sand filters, pumps and large tanks.
- Ensure that *HydroFLOW* is protected from surfaces that may exceed 50°C. Use insulating material and select a larger model if necessary.
- Remember that *HydroFLOW* gradually removes existing scale and that after installation greater than usual quantities of scale particles may be released.

Electrical Loops

An electrical loop is created whenever an electrical connection is made from one side of the ferrite loop to the other, e.g. by metal supports, wiring or pipework. A loop will prevent the unit from operating correctly.

This problem can be solved by moving the unit outside the electrical loop. If this is not possible, the metal support brackets can be electrically insulated. Installing the unit on a section of plastic pipe eliminates the possibility of an electrical loop.

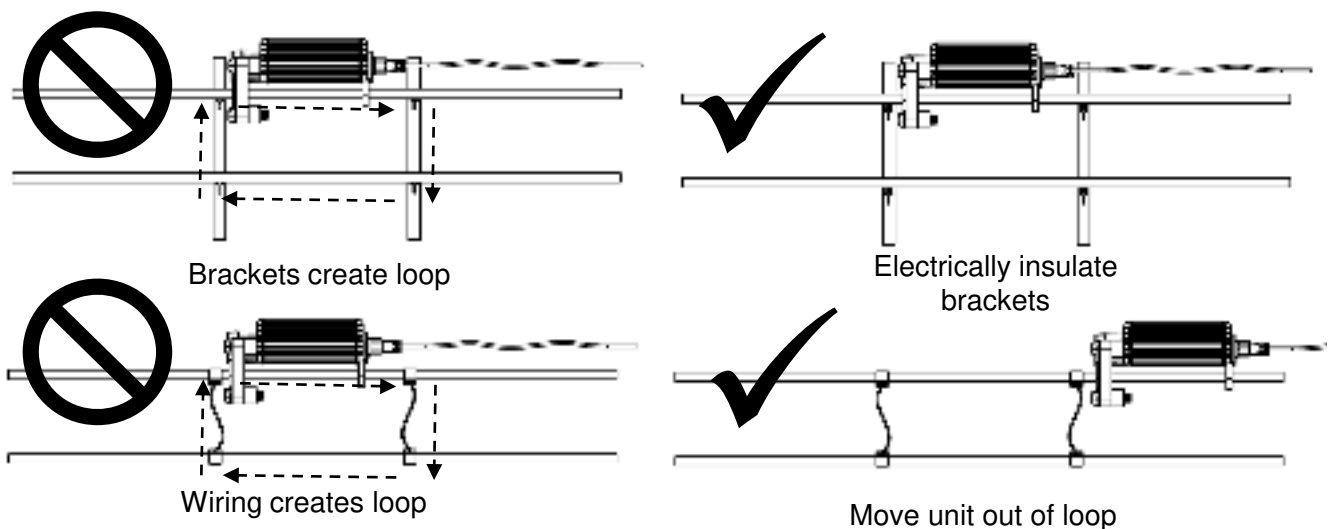

If you are unsure of any details of fitting or installation, please contact your local Hydropath representative for technical support.

Box Contents

Transducer Unit

Instructions

Model	Long ferrites	Short Ferrites	Plastic Hex Nuts	Plastic Thumb Screws	Plastic Thumb Nuts	Steel Bracket	Steel Bands	Pipe clamps	50mm bolts	Steel locking nuts
C45	3	1	2	4	2	1	0	2	4	4
C60	4	0	2	4	2	1	2	0	0	0
C100	1	5	2	6	4	1	2	0	0	0
C130	6	0	2	6	4	1	2	0	0	0
C150	3	5	2	8	6	1	2	0	0	0
C190	8	0	2	8	6	1	2	0	0	0

HYDROPATH

The home of *HydroFLOW*®

To register the product please visit
hydropath.com/product-registration/
Products must be registered to activate any
warranty or guarantee. All goods are sold subject
to our standard terms and conditions of sales,
copies of which are available upon request.







HYDROPATH Technology | The home of *HydroFLOW*®